

GERSTEL

MAKING LABS WORK

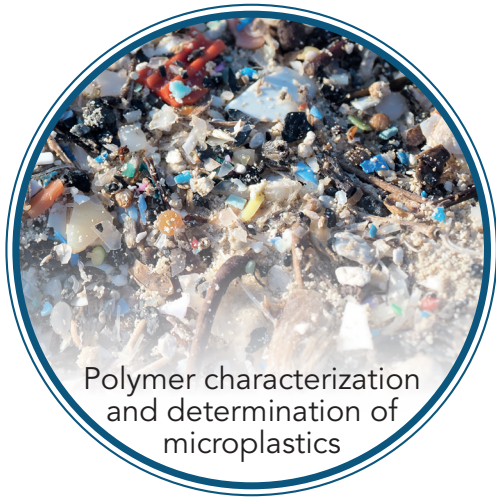

Thermal Extraction and Desorption

TED-GC/MS

TED-GC/MS microplastics analysis

- For Drinking Water, Beverages and Environmental Samples
- Polymer Mass determination in representative sample sizes
- High boiling residue eliminated for best system stability

Unique TGA Interface

Quantitative results

Fully automated system

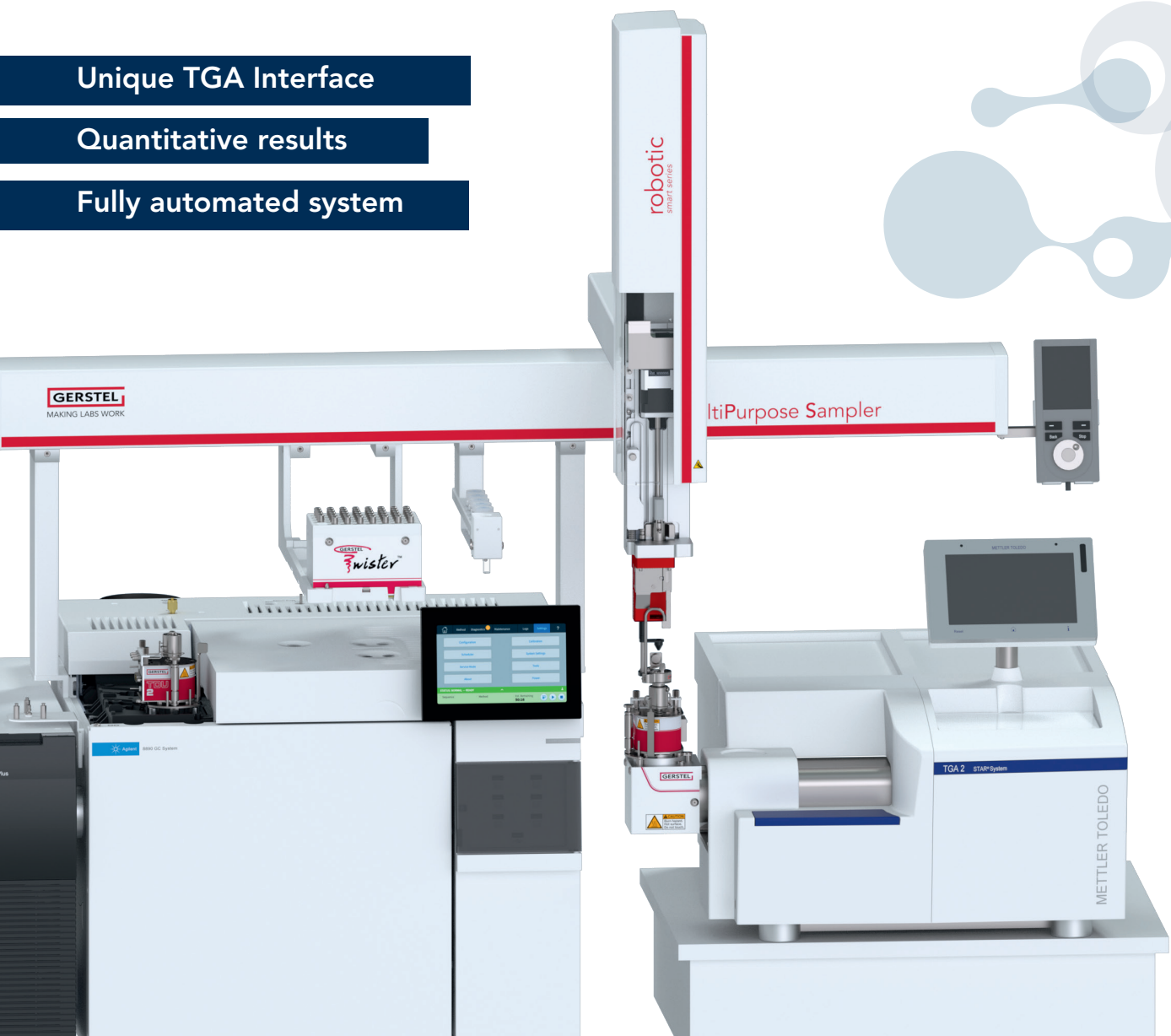

GERSTEL TED-GC/MS system for Microplastics analysis

The GERSTEL Thermal Extraction and Desorption (TED)-GC/MS system performs fully automated determination of microplastics in drinking water, beverage, and environmental water filtration residues, as well as soil, sediment and compost.

Thermal decomposition analysis in the form of Thermogravimetric analysis (TGA) coupled with a concentration step and GC/MS determination of the breakdown products represents a novel and highly interesting approach. The technique enables indirect characterization of microplastics by chemical analysis providing both qualitative and quantitative results, expressed as polymer mass.

TED-GC/MS is a less labor intensive complement to conventional spectroscopy based methods, invented by the Bundesanstalt für Materialforschung und -prüfung (BAM) in Berlin, Germany. The BAM is a senior scientific and technical Federal institute. It tests, researches and advises to protect people, the environment and material goods. In a joint project with GERSTEL, the patented TAU interface, automation and system

integration were developed.

The TED-GC/MS system uses a sorption based collection device (GERSTEL Twister®) mounted in the TGA furnace gas outlet to trap gaseous polymer decomposition products.

An autosampler then transfers the loaded trap to a separate Thermal Desorption (TD)-GC/MS system for analysis. The results enable the analyst to indirectly determine even trace level polymer materials present in the original sample. A complete analysis cycle typically takes only 2 hours.

Using a TGA- rather than a pyrolysis-GC/MS system enables the use of up to 2000 times larger and more representative sample amounts while keeping the GC/MS system clean. The patented TAU interface used in TED-GC/MS system ensures that non-volatile residue never enters the analysis system. TED-GC/MS requires only minimal sample preparation, such as drying and homogenizing the sample.

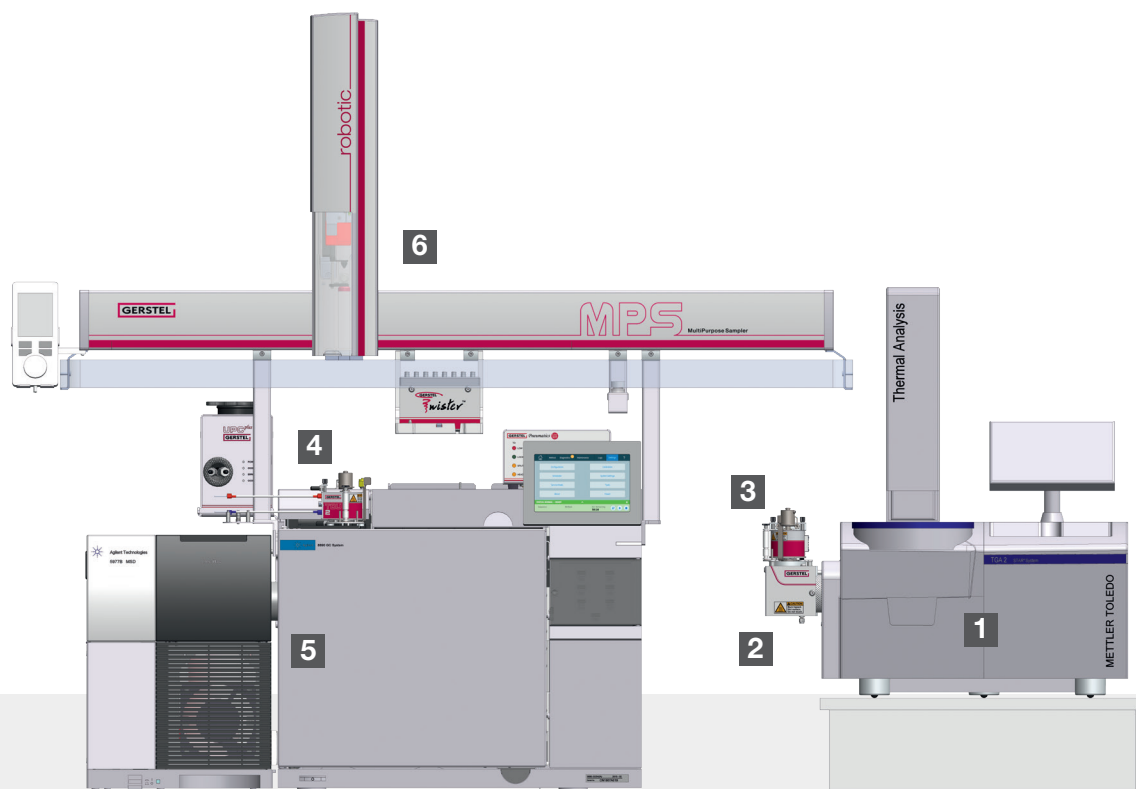

1 TGA

Thermogravimetric Analyzer with dedicated autosampler for up to 34 samples.

2 Dedicated TAU Interface

Patented interface developed by the BAM and GERSTEL for sampling of volatile analytes from the TGA gas outlet and automated transfer of Thermal Desorption Tubes between the TGA and the TDU sample Tray on the MPS.

3 Thermal Desorber for Analyte Collection

Thermal Desorber used for temperature controlled collection of analytes from the TGA purge gas onto the PDMS sorbent (GERSTEL Twister®).

4 Analytical Thermal Desorber

For thermal desorption of the PDMS Twister sorbent traps. A Cooled Injection System (CIS) is used for analyte focusing and transfer to the GC/MS.

5 GC/MS system

For qualitative and quantitative determination of volatile polymer decomposition products and released additives.

6 MultiPurpose Sampler (MPS)

The MPS is operated under integrated GERSTEL MAESTRO software control for fully automated transfer of TGA Twisters in Thermal Desorption tubes between the TGA and GC/MS systems.

TED-GC/MS Features and Benefits

- Fully automated system including optional TGA autosampler and GC/MS autosampler (MPS)
- Two step method for determination of polymers and their thermal decomposition products:
 1. Temperature programmed pyrolysis/thermal decomposition in the TGA combined with solid phase extraction of volatile decomposition products
 2. Thermal desorption of the solid phase trap and GC/MS determination of the analytes
- Concentration on sorbent enables the determination of trace amounts of polymers
- Chemical analysis-based determination for qualitative and quantitative results including polymer mass.
- Analysis of water filtration fractions without additional sample preparation
- Useful for the determination of microplastics in environmental samples:
 - Water filtration residue
 - Soil and sediment
 - Compost
- Reference materials are available from the BAM: https://webshop.bam.de/webshop_en.html
- Multifunctional tool for polymer characterization, including, for example:
 - Primary microplastics and secondary microplastics
 - Thermoplastics, thermosets and elastomers
 - Fractionated characterization of, for example, wood plastic composites (WPCs)

- Compared with pyrolysis-GC/MS, TED-GC/MS provides significant benefits:
 - Larger, more representative, and easier to handle sample amounts (up to 100 mg)
 - Up to 10 L of water or beverage can be filtered in a stainless steel filter crucible and the residue analyzed directly.
 - Elimination of high-boiling and non-volatile thermal decomposition products in the patented TGA-interface for best possible GC/MS system stability
 - Highly effective TGA furnace clean-up at high temperature in oxygen atmosphere between analysis runs
 - Sample weight tracking during the TGA process
 - Deviations in homogeneity between replicate samples are revealed by TGA curve deviations
 - Elimination of secondary reactions due both to the slow heating rate of the furnace compared with pyrolysis GC/MS and to the constant purge of decomposition products. A cleaner and more informative chromatogram is obtained.

ChromIdent® PYRO Edition Software

- ChromIdent software enables accurate identification of polymer materials in complex samples from combination of breakdown products using a novel peak list based database
 - List of >100 frequently encountered polymers with multiple replicates included in database
 - User generated data can be added to the database
 - For varying target mixtures, the ChromIdent software tool facilitates marker identification.
 - Adding data from blank matrices can further improve the quality of the marker search results

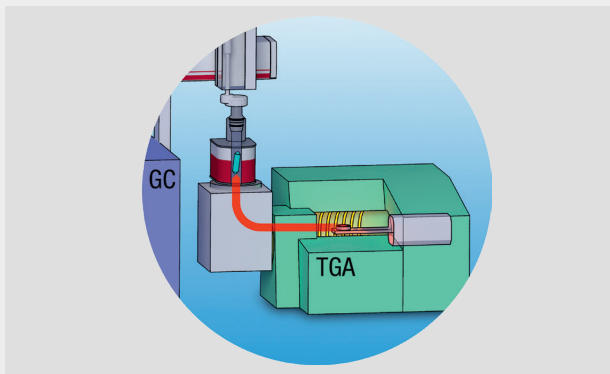

The MPS transfers individual sample tubes containing a PDMS sorbent material to the TED interface synchronized with the TGA run. Emitted volatile organic compounds from the sample and decomposition products formed in the TGA are purged from the furnace area to the TD tube and concentrated in the sorbent material.

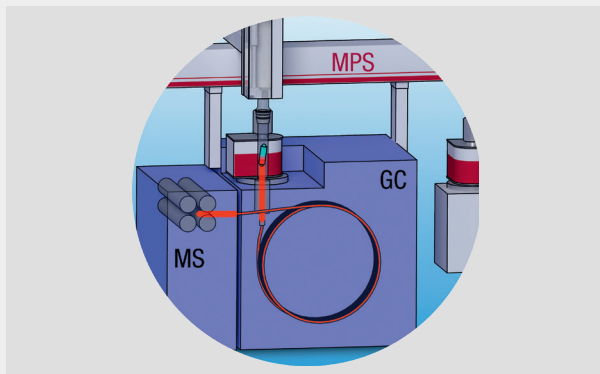

Following the TGA process, the TD tube is picked up by the MPS and transferred to the second Thermal Desorber for analysis. Analytes are released by thermal desorption in the TDU, cryogenically trapped in the CIS inlet and transferred to the attached GC column using temperature programmed vaporization.



Unique TAU Interface

The patented TAU interface developed by the BAM in cooperation with GERSTEL is mounted on the TGA gas outlet.

Evolved gases from the TGA process are transferred to a collection device positioned inside a GERSTEL TDU mounted on the Thermally controlled Adsorption Unit (TAU) interface.

The interface is kept at moderate temperature helping to eliminate high-boiling decomposition products from the purge gas by condensation.

Complex residue therefore never reaches the GC/MS system, ensuring system stability, low background signal and best possible uptime and productivity.

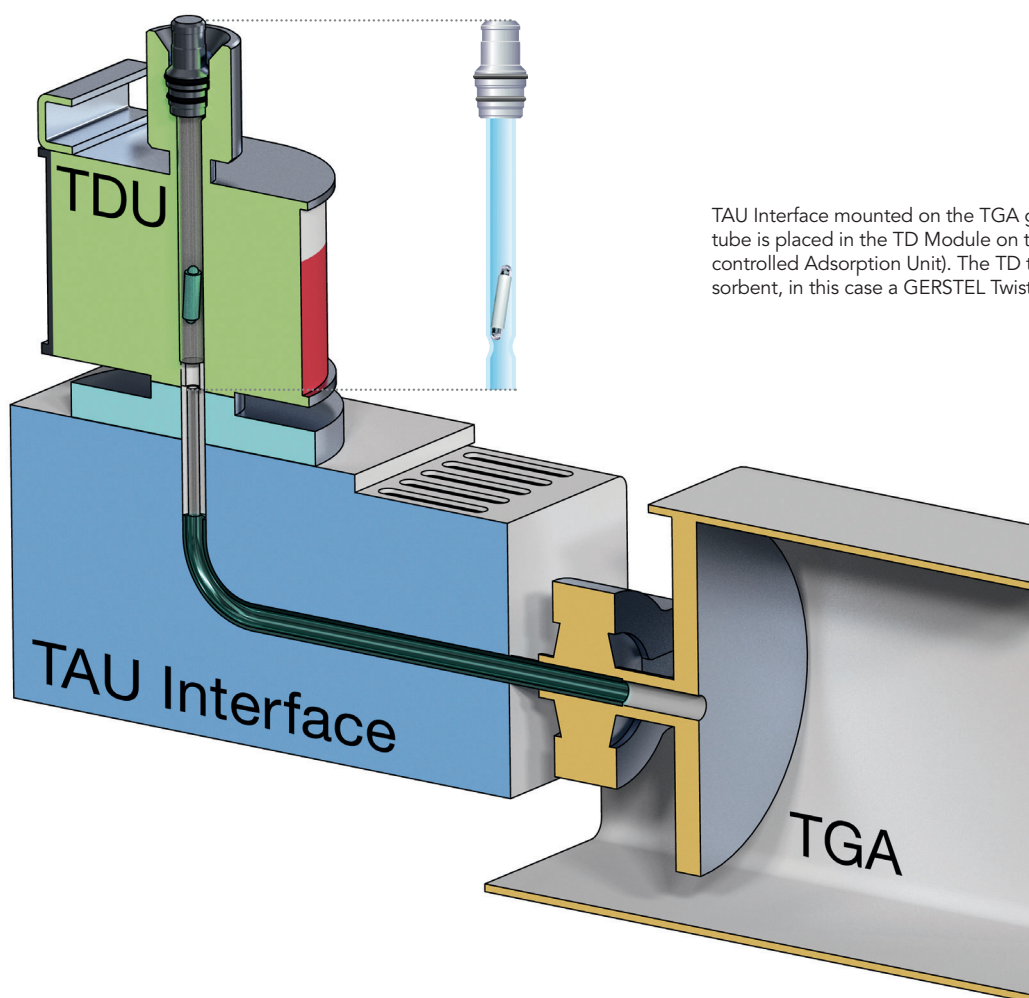

TAU Interface mounted on the TGA gas outlet. A thermal desorption (TD) tube is placed in the TD Module on the TAU Interface (TAU = Thermally controlled Adsorption Unit). The TD tube contains a PDMS solid-phase sorbent, in this case a GERSTEL Twister® used to trap volatile analytes.

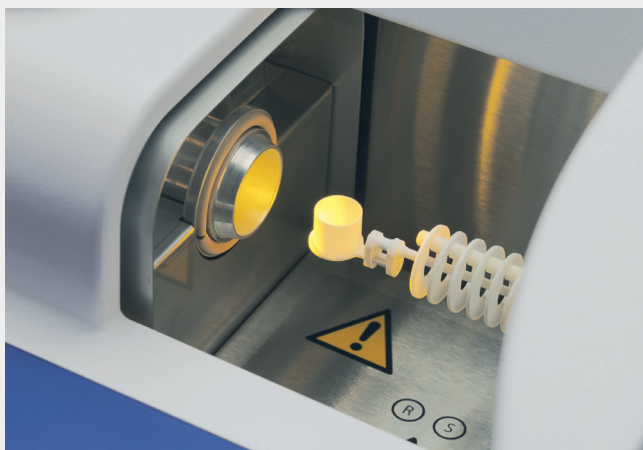

TGA furnace with sample crucible placed on the sample support, which is retracted between analyses.

During the GC/MS run, the TGA furnace is baked out and conditioned to ensure that it is clean and ready for the following analysis.



Automated microplastics analysis in two steps

Thermal decomposition in the TGA is coupled with a concentration step and followed by separate GC/MS determination of the volatile decomposition products. The process enables indirect determination of microplastics by chemical analysis providing both qualitative and quantitative results, enabling polymer mass calculation. A sorption based collection device mounted in the TGA furnace gas outlet collects the volatile polymer decom-

position products. Non-volatile residue is eliminated in the TAU interface, preventing it from reaching and contaminating the GC/MS system. The autosampler then transfers the loaded trap to the Thermal Desorption (TD)-GC/MS system for analysis. The results enable the analyst to determine even trace level polymer materials present in the original sample. The analysis cycle time is typically 2 hours.

1st step: Thermal extraction

Sample placement

The dried sample is placed in the TGA crucible. Representative samples, such as sediment and soil, can be analyzed directly. Up to 10 L of water or beverage sample can be filtered and analyzed using filter crucibles.



© BAM

TGA analysis curve

Weight loss of the sample as a function of temperature can be monitored, for example to verify sample dryness or to check whether replicate samples have identical profiles, as an indicator of sample homogeneity.

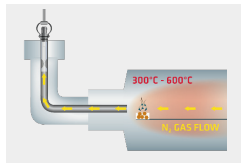

© BAM

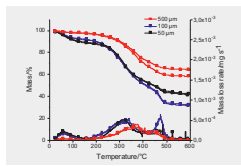

© BAM

Pyrolysis in the TGA furnace

Thermal extraction / pyrolysis of the environmental sample in the TGA furnace. Volatile decomposition products from microplastics in the sample are collected on Polydimethylsiloxane (PDMS), for example using the GERSTEL Twister.

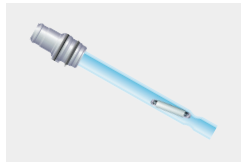

© GERSTEL

TDU tube

The loaded PDMS Twister is transferred to the TD-GC/MS system for analysis.

2nd Step: analysis of the pyrolysis products

Thermal Desorption GC/MS

Analytes are desorbed from the PDMS Twister using thermal desorption and are determined by GC/MS

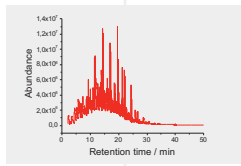

© BAM

Marker Compound Identification

Marker compounds for individual polymer types are identified based on reference data using the ChromIdent® PYRO Edition Software combined with a spectral Library

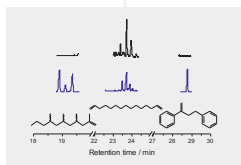

© BAM

Polymer Identification

Polymers in the sample, in this case in several particle size fractions, are identified and quantified based on the marker compounds

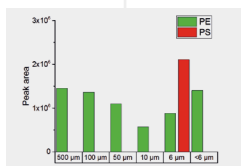

© BAM

Polymer Quantification

Marker compound concentrations are used to calculate the amount of polymer in the sample

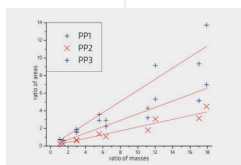

© BAM

Analysis of Microplastics in Drinking Water and Beverages

- Filter crucibles enable direct TED-GC/MS analysis of filtration residue from up to 10 L of sample
 - Material: stainless steel, stable up to 600°C.
 - Pore size: 5 µm
 - Volume: 500 µL
- The filter dimensions are adapted for direct use in TED-GC/MS. The filter crucible was designed for filtration of aqueous samples with a low matrix load, such as water, drinking water or beverages.
- The filters are ready to use. Following the filtration process and a drying step, the crucible is placed in the TED-GC/MS for analysis. The crucibles are reusable.

- Publication:
 - U. Braun, K. Altmann, C. Bannick et al. (2021) Smart filters for the analysis of microplastic in beverages filled in plastic bottles, Food Additives & Contaminants: Part A, 38:4, 691-700, DOI:10.1080/19440049.2021.1889042



Copyright® GKD Gebr. Kufferath AG

GERSTEL CHROMIDENT® PYRO EDITION

A clear view of details in complex samples

The GERSTEL ChromIdent® Pyro Edition software enables efficient determination of even minor amounts of polymer material and other compounds in complex samples. Even when only subsets are in the pyrolysis database, a high rate of success can be achieved, for example when determining pyrolysis breakdown products of microplastics in environmental samples using Thermal Extraction Desorption (TED)-GC/MS. ChromIdent Pyro Edition enables fast search and comparison of chromatograms with a library of

data i.e. a database of peak lists for reliable identification of matching polymers or of complex polymer mixtures present in the sample. Matrix matched standards or reference chromatograms of similar samples are not needed to reach the right answers, even for complex samples. Polymers can be identified reliably and accurately through the use of specific markers and similarity indices based on a peak list query.

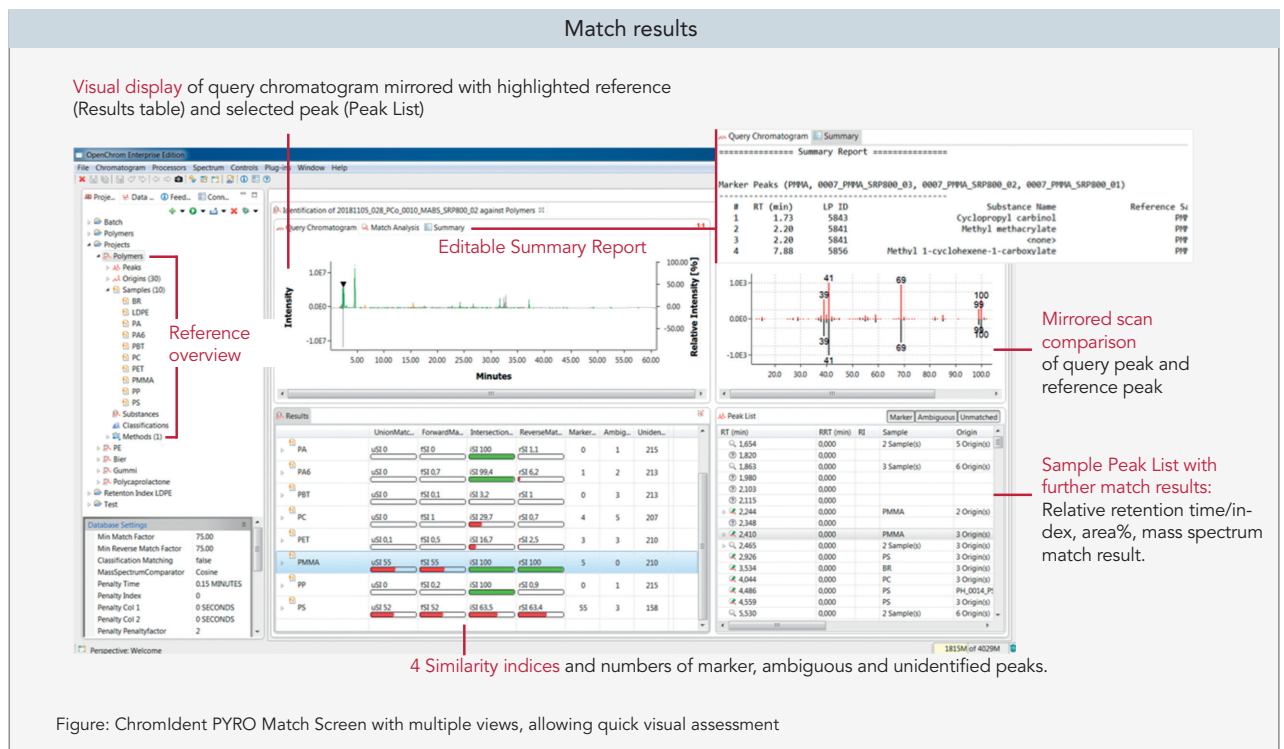

Pyrograms of polymers, co-polymers, biopolymers, as well as mixtures such as vehicle tire rubber are included in the ChromIdent PYRO Database provided with the software. The database contains multiple replicates for many entries leading to improved accuracy and reliability.

Multiple different operations can be performed that enable the identification and contextual assignment of a compound. The database can be expanded using TED-GC/MS data or available pyrolysis-GC/MS data. ChromIdent PYRO accepts MS data formats from a range of different instrument vendors.

During processing, the software performs different operations to enable both determination and classification of sample subsets such as, for example, a polymer or co-polymer.

Color coded match quality indicators provide an at-a-glance overview of the result. As needed, individual peak information can be displayed in a mirrored view with information from the database for easy and reliable direct visual comparison.

Sewage Sludge with TED-GC/MS

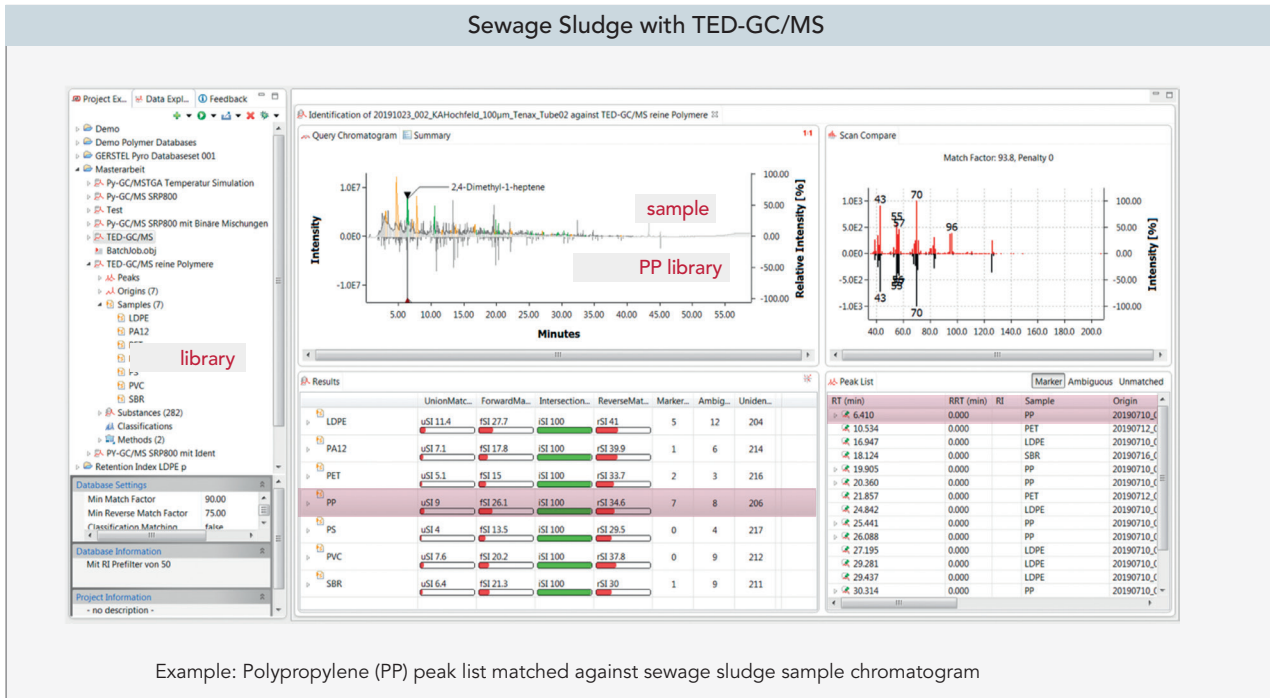

Example: Polypropylene (PP) peak list matched against sewage sludge sample chromatogram

Example: Peak List generated from a chromatogram

The sample peak list is used to match the sample against the database.

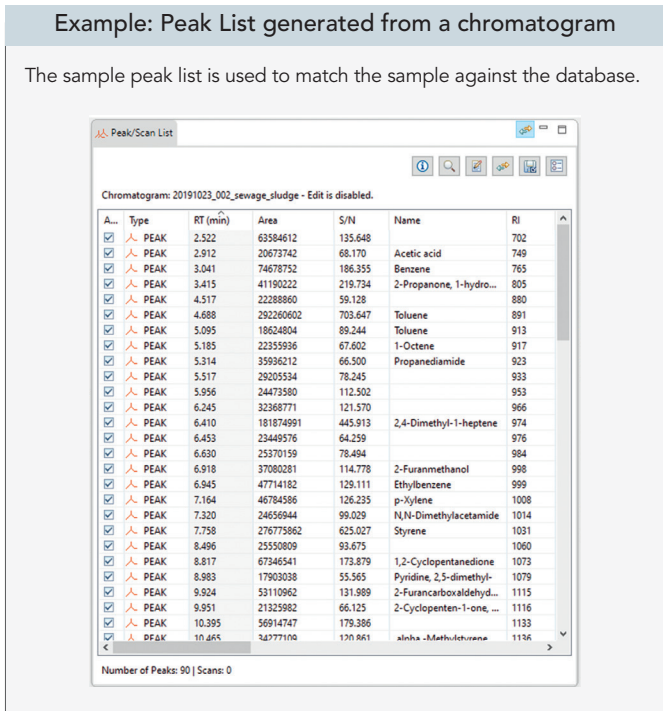

Peer reviewed journal papers

Published by BAM scientists based on TED-GC/MS. These cover polymer characterization as well as determination of microplastics in drinking water, beverages, and in environmental samples ranging from water filtration fractions through soil, silt and sediment to compost.



MAKING LABS WORK

Looking for more?

GERSTEL delivers integrated sample preparation solutions for GC (GC/MS) and HPLC (LC-MS/MS), upon special request adapted to your requirements.

Our proven solutions are based on intelligent combination of market leading Agilent® Technologies instruments

with GERSTEL sample preparation technology under integrated software control.

To ensure your success, GERSTEL provides comprehensive technical and application support by a team of highly experienced and motivated colleagues. For more information, contact your local GERSTEL representative.

Service from day one

Installation and familiarization by fully trained technical staff

Following installation, your system is tested and the service engineer provides the user with a system and software familiarization to ensure that he or she can operate the system and reliably generate results.

Training courses

Comprehensive training courses given by experienced application chemists are available as options. Courses include classroom presentations as well as hands-on instrument operation and maintenance.

GERSTEL systems and solutions are developed, produced and distributed under a quality system certified to meet the demanding ISO 9001:2015 quality standard. Before an instrument or Sample Prep Solution is brought into operation it is tested for technical and application functionality to ensure that it reliably operates to specification.

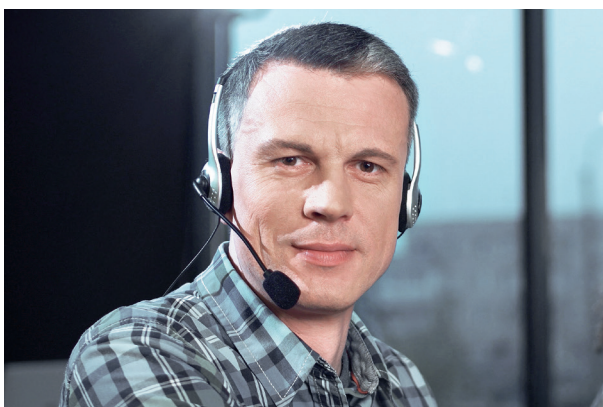

Service and Support

Support to us includes all aspects of our customers' needs: We provide comprehensive professional advice, reliable delivery and thorough training. Whenever technical issues arise, we respond promptly and bring to bear the latest support and communication technology to ensure the fastest possible resolution no matter where in the world our customer is located.

GERSTEL is represented in more than 70 countries worldwide. In territories, where we do not have a GERSTEL Service Organization, our network of trained and certified distributors provide timely, high quality support. Leading laboratories world-wide rely on GERSTEL solutions.



MAKING LABS WORK

GERSTEL GmbH & Co. KG
Eberhard-Gerstel-Platz 1
45473 Mülheim an der Ruhr
Germany

www.gerstel.com

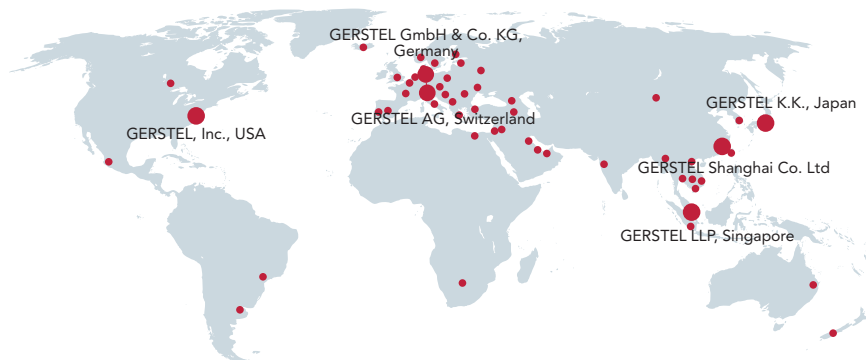

Subject to change. GERSTEL®, GRAPHPACK® and TWISTER® are registered trademarks of GERSTEL GmbH & Co. KG. Copyright by GERSTEL GmbH & Co. KG. Agilent® is a registered trademark of Agilent Technologies, Inc.

